

CERTIFICATE

Certified Passive House Component

Component-ID 0905ws03 valid until 31st December 2023

Passive House Institute
Dr. Wolfgang Feist
64283 Darmstadt
Germany

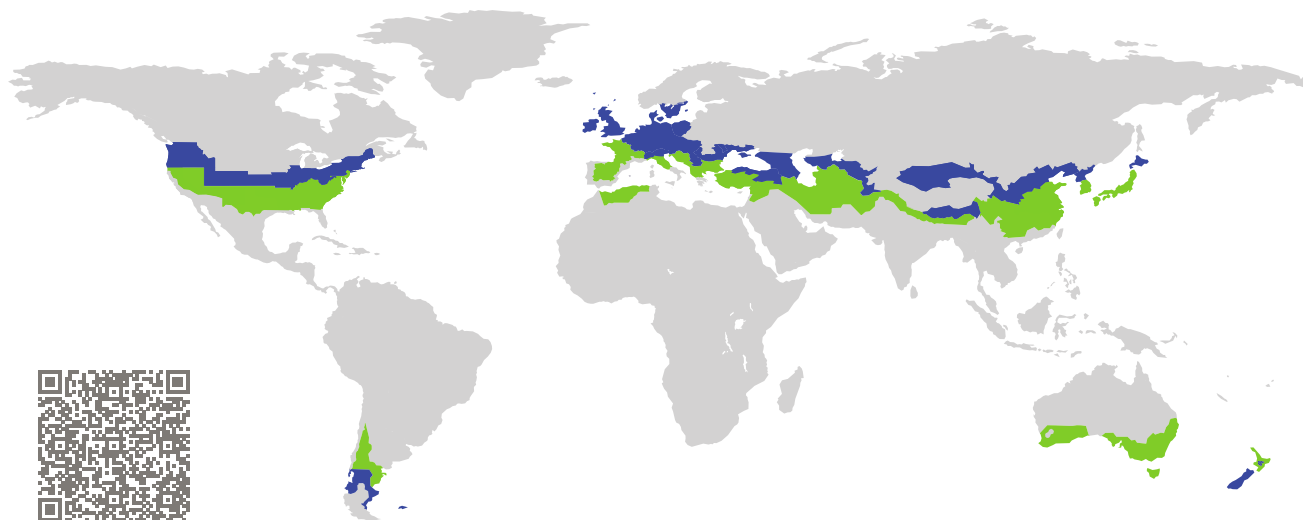

Category: **Window system**
Manufacturer: **pro Passivhausfenster GmbH,
Oberaudorf,
Germany**
Product name: **smartwin**

**This certificate was awarded based on the following
criteria for the cool, temperate climate zone**

Comfort $U_W = 0.77 \leq 0.80 \text{ W}/(\text{m}^2 \cdot \text{K})$
 $U_{W,\text{installed}} \leq 0.85 \text{ W}/(\text{m}^2 \cdot \text{K})$
with $U_g = 0.70 \text{ W}/(\text{m}^2 \cdot \text{K})$

Hygiene $f_{Rsi=0.25} \geq 0.70$
Airtightness $Q_{100} = 0.11 \leq 0.25 \text{ m}^3/(\text{h} \cdot \text{m})$

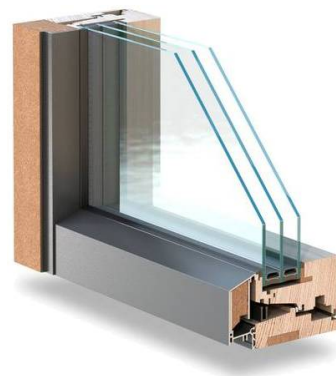

cool, temperate climate



**CERTIFIED
COMPONENT**

Passive House Institute

Passive House
efficiency class

phE

phD

phC

phB

phA

www.passivehouse.com

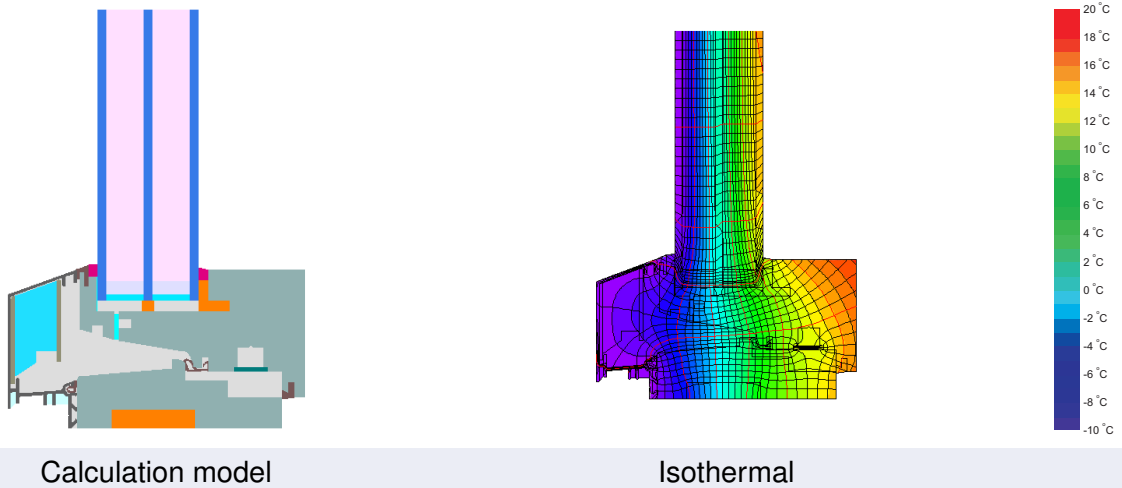

Calculation model Isothermal

Description

Aluminum cladded timber frame (Spruce/Fir, 0.11 W/(mK)), insulated by low dense timber-faser board (0,05 & 0,04 W/(mK)) & PU insulation (0,03 W/(mK)). Glazing: 4/18/4/18/4, Glass intersection: 15 mm Q100 = 0,11 m²/mh tested at a two-sash window with flying mullion (200 * 260 cm) Pane thickness: 48 mm (4/18/4/18/4), rebate depth: 15 mm, spacer: SWISSPACER Ultimate with polyurethane as secondary seal.

Explanation

The window U-values were calculated for the test window size of 2.46 m × 1.48 m with $U_g = 0.70 \text{ W}/(\text{m}^2 \cdot \text{K})$. If a higher quality glazing is used, the window U-values will improve as follows:

Glazing	$U_g =$	0.70	0.64	0.58	0.52	W/(m ² · K)
		↓	↓	↓	↓	
Window	$U_w =$	0.77	0.72	0.67	0.62	W/(m ² · K)

Transparent building components are classified into efficiency classes depending on the heat losses through the opaque part. The frame U-Values, frame widths, thermal bridges at the glazing edge, and the glazing edge lengths are included in these heat losses. A more detailed report of the calculations performed in the context of certification is available from the manufacturer.



The Passive House Institute has defined international component criteria for seven climate zones. In principle, components which have been certified for climate zones with higher requirements may also be used in climates with less stringent requirements. In a particular climate zone it may make sense to use a component of a higher thermal quality which has been certified for a climate zone with more stringent requirements.

Further information relating to certification can be found on www.passivehouse.com and passipedia.org.

Frame values		Frame width b_f mm	U -value frame U_f W/(m ² · K)	Ψ -glazing edge Ψ_g W/(m · K)	Temp. Factor $f_{Rsi=0.25}$ [-]
Mullion fixed	(0M1)	110	0.62	0.021	0.74
Mullion fixed	(0M2)	110	0.78	0.020	0.72
Transom fixed	(0T1)	110	0.79	0.020	0.71
Transom fixed	(0T2)	110	0.79	0.020	0.72
Mullion 1 casement	(1M1)	110	0.73	0.021	0.73
Mullion 1 casement	(1M2)	110	0.92	0.020	0.71
Transom 1 casement	(1T1)	110	0.90	0.020	0.71
Transom 1 casement	(1T2)	110	0.90	0.020	0.71
Mullion 2 casements	(2M1)	142	0.71	0.021	0.74
Mullion 2 casements	(2M2)	142	0.92	0.020	0.72
Transom 2 casements	(2T1)	142	0.92	0.020	0.71
Transom 2 casements	(2T2)	142	0.95	0.020	0.70
door side	(DS1)	142	0.72	0.020	0.73
Bottom fixed	(FB1)	76	0.72	0.020	0.74
Top fixed	(FH1)	67	0.53	0.021	0.76
Lateral fixed	(FJ1)	67	0.53	0.021	0.76
Flying Mullion	(FM1)	110	0.73	0.020	0.74
Flying Mullion	(FM2)	110	0.90	0.020	0.72
Bottom	(OB1)	76	0.93	0.020	0.72

Spacer: SWISSPACER Ultimate

Secondary seal: Polyurethan

Frame values		Frame width b_f mm	U -value frame U_f W/(m ² · K)	Ψ -glazing edge Ψ_g W/(m · K)	Temp. Factor $f_{Rsi=0.25}$ [-]
Top	(OH1) 	67	0.71	0.021	0.75
Lateral	(OJ1) 	67	0.71	0.021	0.75
Threshold	(OT2) 	76	0.97	0.020	0.72

Spacer: SWISSPACER Ultimate Secondary seal: Polyurethan

 Mullion fixed

$b_f = 110$ mm
 $U_f = 0.62$ W/(m² · K)
 $\Psi_g = 0.021$ W/(m · K)
 $f_{Rsi} = 0.74$



 Mullion fixed

$b_f = 110$ mm
 $U_f = 0.78$ W/(m² · K)
 $\Psi_g = 0.020$ W/(m · K)
 $f_{Rsi} = 0.72$



 Transom fixed

$b_f = 110$ mm
 $U_f = 0.79$ W/(m² · K)
 $\Psi_g = 0.020$ W/(m · K)
 $f_{Rsi} = 0.71$



 Transom fixed

$b_f = 110$ mm
 $U_f = 0.79$ W/(m² · K)
 $\Psi_g = 0.020$ W/(m · K)
 $f_{Rsi} = 0.72$





Mullion
1 casement

$$b_f = 110 \text{ mm}$$
$$U_f = 0.73 \text{ W}/(\text{m}^2 \cdot \text{K})$$
$$\Psi_g = 0.021 \text{ W}/(\text{m} \cdot \text{K})$$
$$f_{Rsi} = 0.73$$

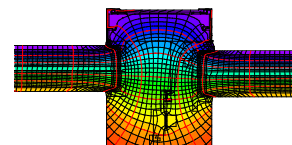
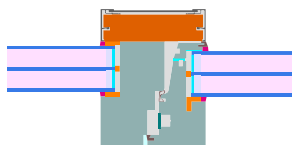

Mullion
1 casement

$$b_f = 110 \text{ mm}$$
$$U_f = 0.92 \text{ W}/(\text{m}^2 \cdot \text{K})$$
$$\Psi_g = 0.020 \text{ W}/(\text{m} \cdot \text{K})$$
$$f_{Rsi} = 0.71$$

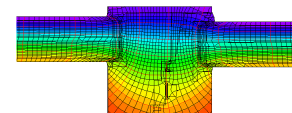

Transom
1 casement

$$b_f = 110 \text{ mm}$$
$$U_f = 0.90 \text{ W}/(\text{m}^2 \cdot \text{K})$$
$$\Psi_g = 0.020 \text{ W}/(\text{m} \cdot \text{K})$$
$$f_{Rsi} = 0.71$$

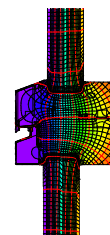
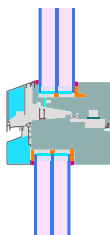

Transom
1 casement

$$b_f = 110 \text{ mm}$$
$$U_f = 0.90 \text{ W}/(\text{m}^2 \cdot \text{K})$$
$$\Psi_g = 0.020 \text{ W}/(\text{m} \cdot \text{K})$$
$$f_{Rsi} = 0.71$$

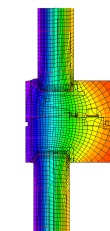

Mullion
2 casements

$$b_f = 142 \text{ mm}$$
$$U_f = 0.71 \text{ W}/(\text{m}^2 \cdot \text{K})$$
$$\Psi_g = 0.021 \text{ W}/(\text{m} \cdot \text{K})$$
$$f_{Rsi} = 0.74$$

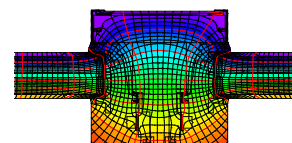
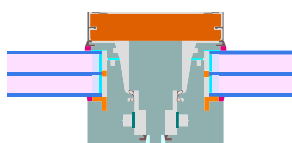



Mullion
2 casements

$$b_f = 142 \text{ mm}$$

$$U_f = 0.92 \text{ W}/(\text{m}^2 \cdot \text{K})$$

$$\Psi_g = 0.020 \text{ W}/(\text{m} \cdot \text{K})$$

$$f_{Rsi} = 0.72$$

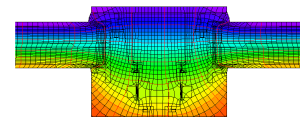
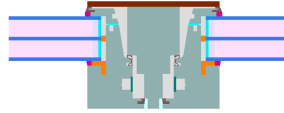

Transom
2 casements

$$b_f = 142 \text{ mm}$$

$$U_f = 0.92 \text{ W}/(\text{m}^2 \cdot \text{K})$$

$$\Psi_g = 0.020 \text{ W}/(\text{m} \cdot \text{K})$$

$$f_{Rsi} = 0.71$$

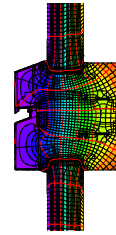

Transom
2 casements

$$b_f = 142 \text{ mm}$$

$$U_f = 0.95 \text{ W}/(\text{m}^2 \cdot \text{K})$$

$$\Psi_g = 0.020 \text{ W}/(\text{m} \cdot \text{K})$$

$$f_{Rsi} = 0.70$$

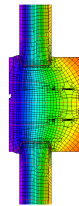

door side

$$b_f = 142 \text{ mm}$$

$$U_f = 0.72 \text{ W}/(\text{m}^2 \cdot \text{K})$$

$$\Psi_g = 0.020 \text{ W}/(\text{m} \cdot \text{K})$$

$$f_{Rsi} = 0.73$$

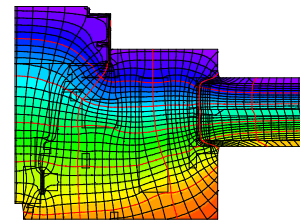
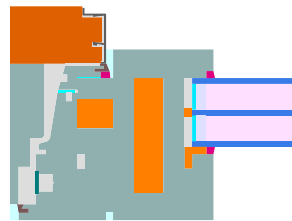

Bottom
fixed

$$b_f = 76 \text{ mm}$$

$$U_f = 0.72 \text{ W}/(\text{m}^2 \cdot \text{K})$$

$$\Psi_g = 0.020 \text{ W}/(\text{m} \cdot \text{K})$$

$$f_{Rsi} = 0.74$$

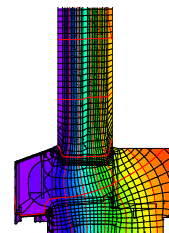
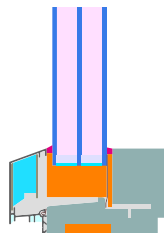



Top
fixed

$$b_f = 67 \text{ mm}$$

$$U_f = 0.53 \text{ W}/(\text{m}^2 \cdot \text{K})$$

$$\Psi_g = 0.021 \text{ W}/(\text{m} \cdot \text{K})$$

$$f_{Rsi} = 0.76$$

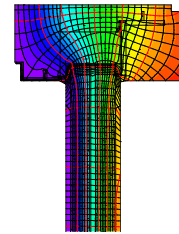
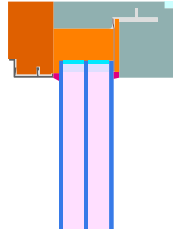

Lateral
fixed

$$b_f = 67 \text{ mm}$$

$$U_f = 0.53 \text{ W}/(\text{m}^2 \cdot \text{K})$$

$$\Psi_g = 0.021 \text{ W}/(\text{m} \cdot \text{K})$$

$$f_{Rsi} = 0.76$$

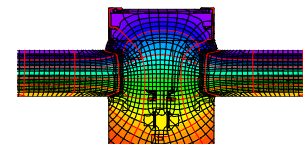
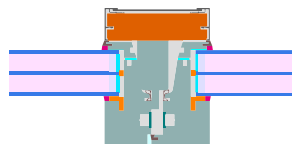

Flying Mullion

$$b_f = 110 \text{ mm}$$

$$U_f = 0.73 \text{ W}/(\text{m}^2 \cdot \text{K})$$

$$\Psi_g = 0.020 \text{ W}/(\text{m} \cdot \text{K})$$

$$f_{Rsi} = 0.74$$

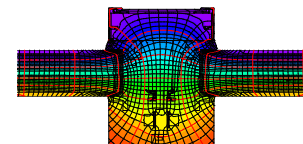
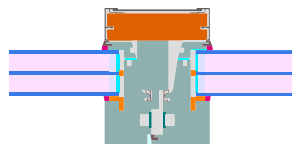

Flying Mullion

$$b_f = 110 \text{ mm}$$

$$U_f = 0.90 \text{ W}/(\text{m}^2 \cdot \text{K})$$

$$\Psi_g = 0.020 \text{ W}/(\text{m} \cdot \text{K})$$

$$f_{Rsi} = 0.72$$

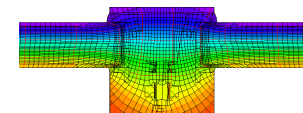
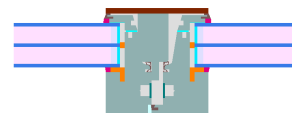

Bottom

$$b_f = 76 \text{ mm}$$

$$U_f = 0.93 \text{ W}/(\text{m}^2 \cdot \text{K})$$

$$\Psi_g = 0.020 \text{ W}/(\text{m} \cdot \text{K})$$

$$f_{Rsi} = 0.72$$

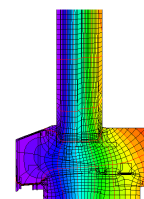
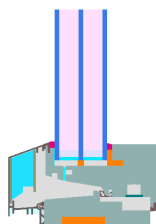



Top

$$b_f = 67 \text{ mm}$$
$$U_f = 0.71 \text{ W}/(\text{m}^2 \cdot \text{K})$$
$$\Psi_g = 0.021 \text{ W}/(\text{m} \cdot \text{K})$$
$$f_{Rsi} = 0.75$$

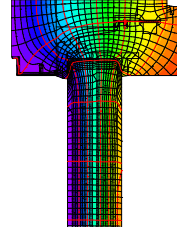
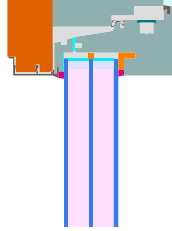

Lateral

$$b_f = 67 \text{ mm}$$
$$U_f = 0.71 \text{ W}/(\text{m}^2 \cdot \text{K})$$
$$\Psi_g = 0.021 \text{ W}/(\text{m} \cdot \text{K})$$
$$f_{Rsi} = 0.75$$



Threshold

$$b_f = 76 \text{ mm}$$
$$U_f = 0.97 \text{ W}/(\text{m}^2 \cdot \text{K})$$
$$\Psi_g = 0.020 \text{ W}/(\text{m} \cdot \text{K})$$
$$f_{Rsi} = 0.72$$

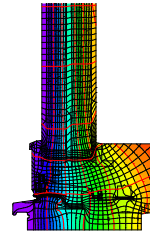
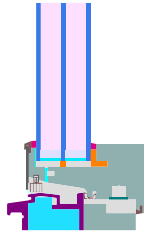

Validated installations

Formwork blocks (fixed)

$U_{Wall} = 0.15 \text{ W}/(\text{m}^2 \cdot \text{K})$

$\Psi_{install}$	$\text{W}/(\text{m} \cdot \text{K})$
Top	0.005
Left	0.005
Right	0.005
Bottom	0.022

$U_{W,installed} = 0.79 \text{ W}/(\text{m}^2 \cdot \text{K})$

Formwork blocks (operable)

$U_{Wall} = 0.15 \text{ W}/(\text{m}^2 \cdot \text{K})$

$\Psi_{install}$	$\text{W}/(\text{m} \cdot \text{K})$
Top	0.006
Left	0.006
Right	0.006
Bottom	0.024

$U_{W,installed} = 0.79 \text{ W}/(\text{m}^2 \cdot \text{K})$

Lightweight timber (fixed glazed)

$U_{Wall} = 0.13 \text{ W}/(\text{m}^2 \cdot \text{K})$

$\Psi_{install}$	$\text{W}/(\text{m} \cdot \text{K})$
Top	0.015
Left	0.015
Right	0.015
Bottom	0.024

$U_{W,installed} = 0.81 \text{ W}/(\text{m}^2 \cdot \text{K})$

Lightweight timber (operable)

$U_{Wall} = 0.13 \text{ W}/(\text{m}^2 \cdot \text{K})$

$\Psi_{install}$	$\text{W}/(\text{m} \cdot \text{K})$
Top	0.015
Left	0.015
Right	0.015
Bottom	0.023

$U_{W,installed} = 0.81 \text{ W}/(\text{m}^2 \cdot \text{K})$

Threshold balcony door

$U_{Wall} = 0.13 \text{ W}/(\text{m}^2 \cdot \text{K})$

$\Psi_{install}$	$\text{W}/(\text{m} \cdot \text{K})$
Top	
Left	
Right	
Bottom	0.014

$U_{W,installed} = \text{W}/(\text{m}^2 \cdot \text{K})$

Exterior insulation and finishing system (EIFS) (fixed glazed)

$U_{Wall} = 0.13 \text{ W}/(\text{m}^2 \cdot \text{K})$

$\Psi_{install}$	$\text{W}/(\text{m} \cdot \text{K})$
Top	0.003
Left	0.003
Right	0.003
Bottom	0.021

$U_{W,installed} = 0.79 \text{ W}/(\text{m}^2 \cdot \text{K})$

